

Dual 150mA CMOS LDO With Select Mode™ Operation, Shutdown and RESET Output

Features

- Extremely Low Supply Current for Longer Battery Life
- Select Mode™ Operation: Selectable Output Voltages for High Design Flexibility
- Very Low Dropout Voltage
- 10µsec (Typ.) Wake-Up Time from $\overline{\text{SHDN}}$
- Maximum 150mA Output Current per Output
- High Output Voltage Accuracy
- Power-Saving Shutdown Mode
- $\overline{\text{RESET}}$ Output Can Be Used as a Low Battery Detector or Processor Reset Generator
- Over Current Protection and Over Temperature Shutdown
- Space Saving 8-Pin MSOP Package

Applications

- Load Partitioning
- Battery Operated Systems
- Portable Computers
- Medical Instruments
- Instrumentation
- Pagers and Cellular/GSM/PHS Phones
- Linear Post-Regulator for SMPS

Device Selection Table

Part Number	Package	Junction Temperature Range
TC1306R-BDVUA	8-Pin MSOP	-40°C to +125°C

NOTE: "R" denotes the suffix for the 2.63V RESET threshold.
 "B" indicates $V_{\text{OUT1}} = 1.8\text{V}$ (fixed).
 "D" indicates $V_{\text{OUT2}} = 2.8\text{V}, 3.0\text{V}$ (selectable).

Other output voltages are available. Please contact Microchip Technology Inc. for details.

Package Type

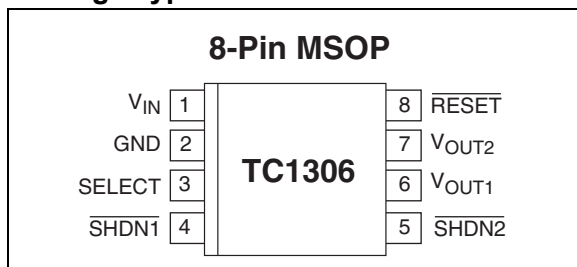

General Description

The TC1306 combines two CMOS Low Dropout Regulators and a Microprocessor Monitor in a space saving 8-Pin MSOP package. Designed specifically for battery operated systems, total supply current is typically 120µA at full load, 20 to 60 times lower than in bipolar regulators.

The TC1306 features selectable output voltages for higher design flexibility. The dual-state SELECT input pin allows the user to select V_{OUT2} from 2 different values (2.8V and 3.0V). V_{OUT1} supplies a fixed 1.8V voltage.

An active low $\overline{\text{RESET}}$ is asserted when the output voltage V_{OUT2} falls below the 2.63V reset voltage threshold. The RESET output remains low for 300msec (typical) after V_{OUT2} rises above reset threshold. When the shutdown control ($\overline{\text{SHDN1}}$) is low, the regulator output voltage V_{OUT1} falls to zero and $\overline{\text{RESET}}$ output remains valid. When the shutdown control ($\overline{\text{SHDN2}}$) is low, the regulator output voltage V_{OUT2} falls to zero and RESET output is low.

Other key features for the device include ultra low noise operation, fast response to step changes in load and very low dropout voltage (typically 125mV at full load). The device also incorporates both over temperature and over current protection. Each regulator is stable with an output capacitor of only 1µF and has a maximum output current of 150mA.

Typical Application

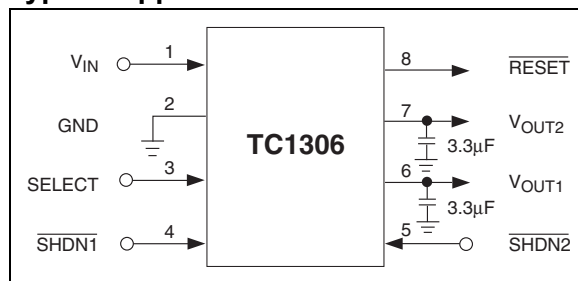

TC1306

1.0 ELECTRICAL CHARACTERISTICS

ABSOLUTE MAXIMUM RATINGS*

Input Voltage	6.5V
Output Voltage.....	(-0.3V) to (V _{IN} + 0.3V)
Power Dissipation.....	Internally Limited (Note 7)
Maximum Voltage on Any Pin	V _{IN} + 0.3V to -0.3V
Operating Temperature Range....	-40°C < T _J < +125°C
Storage Temperature Range	-65°C to +150°C

*Stresses above those listed under "Absolute Maximum Ratings" may cause permanent damage to the device. These are stress ratings only and functional operation of the device at these or any other conditions above those indicated in the operation sections of the specifications is not implied. Exposure to Absolute Maximum Rating conditions for extended periods may affect device reliability.

TC1306 ELECTRICAL SPECIFICATIONS

Electrical Characteristics: V _{IN} = V _R + 1V, I _L = 100μA, C _L = 3.3μF, SHDN1 > V _{IH} , SHDN2 > V _{IH} , T _A = 25°C, unless otherwise noted. Boldface type specifications apply for junction temperature of -40°C to +125°C. Applies to both V _{OUT1} and V _{OUT2} .						
Symbol	Parameter	Min	Typ	Max	Units	Test Conditions
V _{IN}	Input Operating Voltage	2.7	—	6.0	V	Note 1
I _{OUTMAX}	Maximum Output Current	150	—	—	mA	Per Channel
V _{OUT}	Output Voltage (V _{OUT1} and V _{OUT2})	V_R - 2.5%	V _R ± 0.5%	V_R + 2.5%	V	Note 2
TCV _{OUT}	V _{OUT} Temperature Coefficient	—	20 40	—	ppm/°C	Note 3
ΔV _{OUT} /ΔV _{IN}	Line Regulation	—	0.05	0.35	%	(V _R + 1V) ≤ V _{IN} ≤ 6V
ΔV _{OUT} /V _{OUT}	Load Regulation	—	0.3	2	%	I _L = 0.1mA to I _{OUTMAX} (Note 4)
V _{IN} - V _{OUT}	Dropout Voltage	—	2 45 85 125	— 120 240 360	mV	I _L = 100μA I _L = 50mA I _L = 100mA I _L = 150mA, (Note 5)
I _{IN}	Supply Current	—	120	200	μA	SHDN1, SHDN2 = V _{IH} , I _L = 0
I _{INSD}	Shutdown Supply Current	—	0.05	0.5	μA	SHDN1, SHDN2 = 0V
PSRR	Power Supply Rejection Ratio	—	55	—	dB	F _{RE} ≤ 120Hz
I _{OUTSC}	Output Short Circuit Current	—	450	—	mA	V _{OUT} = 0V
ΔV _{OUT} /ΔP _D	Thermal Regulation	—	0.04	—	V/W	Notes 6, 7
t _{WK}	Wake Up Time (from Shutdown Mode)	—	10	—	μsec	V _{IN} = 5V C _{IN} = 1μF, C _{OUT} = 4.7μF I _L = 30mA, (See Figure 4-1)
t _s	Settling Time (from Shutdown Mode)	—	40	—	μsec	V _{IN} = 5V C _{IN} = 1μF, C _{OUT} = 4.7μF I _L = 30mA, (See Figure 4-1)

Note 1: The minimum V_{IN} has to meet two conditions: V_{IN} ≥ 2.7 and V_{IN} = V_R + V_{DROPOUT}.

Note 2: V_R is the regulator output voltage setting. For example: V_R = 2.8V, 3.0V.

Note 3: T_C V_{OUT} = (V_{OUTMAX} - V_{OUTMIN}) × 10⁶ / (V_{OUT} × ΔT)

Note 4: Regulation is measured at a constant junction temperature using low duty cycle pulse testing. Load regulation is tested over a load range from 0.1mA to the maximum specified output current. Changes in output voltage due to heating effects are covered by the thermal regulation specification.

Note 5: Dropout voltage is defined as the input to output differential at which the output voltage drops 2% below its nominal value measured at a 1V differential.

Note 6: Thermal Regulation is defined as the change in output voltage at a time T after a change in power dissipation is applied, excluding load or line regulation effects. Specifications are for a current pulse equal to I_{LMAX} at V_{IN} = 6V for T = 10 msec.

Note 7: The maximum allowable power dissipation is a function of ambient temperature, the maximum allowable junction temperature and the thermal resistance from junction-to-air (i.e., T_A, T_J, θ_{JA}). Exceeding the maximum allowable power dissipation causes the device to initiate thermal shutdown. Please see Section 5.0 Thermal Considerations section of this data sheet for more details.

TC1306 ELECTRICAL SPECIFICATIONS (CONTINUED)

Electrical Characteristics: $V_{IN} = V_R + 1V$, $I_L = 100\mu A$, $C_L = 3.3\mu F$, $\overline{SHDN1} > V_{IH}$, $\overline{SHDN2} > V_{IH}$, $T_A = 25^\circ C$, unless otherwise noted. **Boldface** type specifications apply for junction temperature of $-40^\circ C$ to $+125^\circ C$. Applies to both V_{OUT1} and V_{OUT2} .

Symbol	Parameter	Min	Typ	Max	Units	Test Conditions
T_{SD}	Thermal Shutdown Die Temperature	—	160	—	$^\circ C$	
ΔT_{SD}	Thermal Shutdown Hysteresis	—	15	—	$^\circ C$	
eN	Output Noise	—	200	—	$nV\sqrt{Hz}$	F = 10kHz
SHDN Input						
V_{IH}	\overline{SHDN} Input High Threshold	65	—	—	% V_{IN}	$V_{IN} = 2.7V$ to $6.0V$
V_{IL}	\overline{SHDN} Input Low Threshold	—	—	15	% V_{IN}	$V_{IN} = 2.7V$ to $6.0V$
SELECT Input						
V_{SELH}	SELECT Input High Threshold	65	—	—	% V_{IN}	$V_{IN} = 2.7V$ to $6.0V$
V_{SELL}	SELECT Input Low Threshold	—	—	15	% V_{IN}	$V_{IN} = 2.7V$ to $6.0V$
RESET Output						
V_{INMIN}	Minimum V_{IN} Operating Voltage	1.0 1.2	—	6.0 6.0	V	$T_A = 0^\circ C$ to $+70^\circ C$ $T_A = -40^\circ C$ to $+125^\circ C$
V_{TH}	Reset Threshold	2.59 2.55	2.63 —	2.66 2.70	V	$T_A = +25^\circ C$ $T_A = -40^\circ C$ to $+125^\circ C$
	Reset Threshold Tempco	—	30	—	ppm/ $^\circ C$	
	V_{OUT2} to Reset Delay	—	100	—	μsec	$V_{OUT2} = V_{TH}$ to $(V_{TH} - 100mV)$
	Reset Active Time-out Period	140	300	560	msec	
V_{OL}	\overline{RESET} Output Voltage Low	—	—	0.3	V	$V_{OUT2} = V_{THMIN}$, $I_{SINK} = 1.2mA$ $V_{OUT2} = V_{THMIN}$, $I_{SINK} = 3.2mA$ $V_{OUT2} > 1.0V$, $I_{SINK} = 50\mu A$
		—	—	0.4		
		—	—	0.3		
V_{OH}	\overline{RESET} Output Voltage High	$0.8 V_{OUT2}$	—	—	V	$V_{OUT2} > V_{THMAX}$, $I_{SOURCE} = 500\mu A$ $V_{OUT2} > V_{THMAX}$, $I_{SOURCE} = 800\mu A$
		$V_{OUT2} - 1.5$	—	—		

Note 1: The minimum V_{IN} has to meet two conditions: $V_{IN} \geq 2.7$ and $V_{IN} = V_R + V_{DROPOUT}$.
2: V_R is the regulator output voltage setting. For example: $V_R = 2.8V$, $3.0V$.

3:
$$T_C V_{OUT} = \frac{(V_{OUTMAX} - V_{OUTMIN}) \times 10^6}{V_{OUT} \times \Delta T}$$

- 4: Regulation is measured at a constant junction temperature using low duty cycle pulse testing. Load regulation is tested over a load range from 0.1mA to the maximum specified output current. Changes in output voltage due to heating effects are covered by the thermal regulation specification.
- 5: Dropout voltage is defined as the input to output differential at which the output voltage drops 2% below its nominal value measured at a 1V differential.
- 6: Thermal Regulation is defined as the change in output voltage at a time T after a change in power dissipation is applied, excluding load or line regulation effects. Specifications are for a current pulse equal to I_{LMAX} at $V_{IN} = 6V$ for T = 10 msec.
- 7: The maximum allowable power dissipation is a function of ambient temperature, the maximum allowable junction temperature and the thermal resistance from junction-to-air (i.e., T_A , T_J , θ_{JA}). Exceeding the maximum allowable power dissipation causes the device to initiate thermal shutdown. Please see Section 5.0 Thermal Considerations section of this data sheet for more details.

TC1306

2.0 PIN DESCRIPTIONS

The descriptions of the pins are listed in Table 2-1.

TABLE 2-1: PIN FUNCTION TABLE

Pin No. (8-Pin MSOP)	Symbol	Description
1	V_{IN}	Power supply input.
2	GND	Ground terminal.
3	SELECT	SELECT control for setting V_{OUT2} . SELECT = Low for $V_{OUT2} = 2.8V$, SELECT = High for $V_{OUT2} = 3.0V$.
4	$\overline{SHDN1}$	Shutdown control input for V_{OUT1} . Regulator 1 is fully enabled when a logic high is applied to this input. Regulator 1 enters shutdown when a logic low is applied to this input. During shutdown, regulator output voltage falls to zero, \overline{RESET} output remains valid.
5	$\overline{SHDN2}$	Shutdown control input for V_{OUT2} . Regulator 2 is fully enabled when a logic high is applied to this input. Regulator 2 enters shutdown when a logic low is applied to this input. During shutdown, regulator output voltage falls to zero, \overline{RESET} output is low.
6	V_{OUT1}	Regulated voltage output 1.
7	V_{OUT2}	Regulated voltage output 2.
8	\overline{RESET}	\overline{RESET} Output. $\overline{RESET} = \text{Low}$ when V_{OUT2} is below the Reset Threshold Voltage. $\overline{RESET} = \text{High}$ when V_{OUT2} is above the Reset Threshold Voltage.

3.0 DETAILED DESCRIPTION

The TC1306 is a precision fixed output voltage regulator that contains two fully independent 150mA outputs. The device also features separate shutdown modes for low-power operation. The Select Mode™ operation allows the user to select V_{OUT2} from two different values (2.8V, 3.0V), therefore providing high design flexibility. V_{OUT1} supplies a fixed 1.8V output voltage. The CMOS construction of the TC1306 results in a very low supply current, which does not increase with load changes. In addition, V_{OUT} remains stable and within regulation at no load currents.

The TC1306 also features an integrated microprocessor supervisor that monitors the V_{OUT2} output. The active low \overline{RESET} signal is asserted when the voltage of V_{OUT2} falls below the reset voltage threshold (2.63V). The \overline{RESET} output remains low for 300msec (typical) after V_{OUT2} rises above the reset threshold. The \overline{RESET} output of the TC1306 is optimized to reject fast transient glitches on the monitored output line.

4.0 TYPICAL APPLICATIONS

4.1 Input and Output Capacitor

The TC1306 is stable with a wide range of capacitor values and types. A capacitor with a minimum value of $1\mu\text{F}$ from V_{OUT} to Ground is required. The output capacitor should have an effective series resistance (ESR) of 0.1Ω to 10Ω for a $1\mu\text{F}$ capacitor and 0.01Ω to 10Ω for a $10\mu\text{F}$ capacitor. A $1\mu\text{F}$ capacitor should be connected from the V_{IN} to GND if there is more than 10 inches of wire between the regulator and the AC filter capacitor, or if a battery is used as the power source. Aluminum electrolytic or tantalum capacitor types can be used. (Since many aluminum electrolytic capacitors freeze at approximately -30°C , solid tantalums are recommended for applications operating below -20°C). When operating from sources other than batteries, supply-noise rejection and transient response can be improved by increasing the value of the input and output capacitors and employing passive filtering techniques.

4.2 Shutdown Mode

Applying a logic high to each of the shutdown pins turns on the corresponding output. Each regulator enters shutdown mode when a logic low is applied to the corresponding input. During shutdown mode, output voltage falls to zero, and regulator supply current is reduced to $0.5\mu\text{A}$ (max). If shutdown mode is not necessary, the pins should be connected to V_{IN} .

4.3 Select Mode™ Operation

The Select Mode™ operation is a dual-state input that allows the user to select $V_{\text{OUT}2}$ from two different values. By applying a logic low to the SELECT pin, $V_{\text{OUT}2}$ is set to supply a 2.8V output voltage. A logic high signal at the SELECT pin sets $V_{\text{OUT}2}$ to 3.0V. This output voltage functionality provides high design flexibility and minimizes cost associated with inventory, time-to-market and new device qualifications.

4.4 Turn On Response

The turn on response is defined as two separate response categories, Wake Up Time (t_{WK}) and Settling Time (t_{S}).

The TC1306 has a fast Wake Up Time ($10\mu\text{sec}$ typical) when released from shutdown. See Figure 4-1 for the Wake Up Time designated as t_{WK} . The Wake Up Time is defined as the time it takes for the output to rise to 2% of the V_{OUT} value after being released from shutdown.

The total turn on response is defined as the Settling Time (t_{S}), see Figure 4-1. Settling Time (inclusive with t_{WK}) is defined as the condition when the output is within 2% of its fully enabled value ($40\mu\text{sec}$ typical) when released from shutdown. The settling time of the output voltage is dependent on load conditions, output voltage and V_{OUT} (RC response).

FIGURE 4-1: WAKE-UP RESPONSE TIME

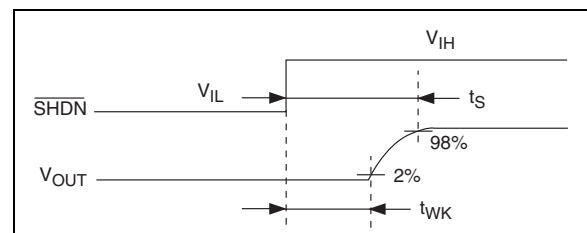

5.0 THERMAL CONSIDERATIONS

5.1 Thermal Shutdown

Integrated thermal protection circuitry shuts the regulator off when die exceeds approximately 160°C. The regulator remains off until the die temperature drops to approximately 145°C.

Thermal shutdown is intended to protect the device under transient accidental (fault) overload conditions. Thermal Shutdown may not protect the LDO while operating above junction temperatures of 125°C continuously. Sufficient thermal evaluation of the design needs to be conducted to ensure that the junction temperature does not exceed 125°C.

5.2 Power Dissipation

The amount of power the regulator dissipates is primarily a function of input and output voltage, and output current. The following equation is used to calculate worst case *actual* power dissipation.

EQUATION 5-1:

$$P_D \approx (V_{INMAX} - V_{OUT1MIN})I_{LOAD1MAX} + (V_{INMAX} - V_{OUT2MIN})I_{LOAD2MAX}$$

Where:

- P_D = Worst case actual power dissipation
- V_{INMAX} = Maximum voltage on V_{IN}
- $V_{OUT1MIN}$ = Minimum regulator output voltage1
- $I_{LOAD1MAX}$ = Maximum output (load) current1
- $V_{OUT2MIN}$ = Minimum regulator output voltage2
- $I_{LOAD2MAX}$ = Maximum output (load) current2

The maximum *allowable* power dissipation (Equation 5-2) is a function of the maximum ambient temperature (T_{AMAX}), the maximum allowable die temperature (125°C), and the thermal resistance from junction-to-air (θ_{JA}). The MSOP-8 package has a θ_{JA} of approximately 200°C/W when mounted on a four layer FR4 dielectric copper clad PC board.

EQUATION 5-2:

$$P_{DMAX} = \frac{(T_{JMAX} - T_{AMAX})}{\theta_{JA}}$$

Where all terms are previously defined.

Equation 5-1 can be used in conjunction with Equation 5-2 to ensure regulator thermal operation is within limits. For example:

Given:

$$\begin{aligned} V_{INMAX} &= 3.8V \pm 5\% \\ V_{OUT1MIN} &= 1.8V \pm 2.5\% \\ V_{OUT2MIN} &= 3.0V \pm 2.5\% \\ I_{LOAD1MAX} &= 60mA \\ I_{LOAD2MAX} &= 120mA \\ T_{JMAX} &= 125^\circ C \\ T_{AMAX} &= 55^\circ C \\ \theta_{JA} &= 200^\circ C/W \end{aligned}$$

- Find: 1. Actual power dissipation
2. Maximum allowable dissipation

Actual power dissipation:

$$\begin{aligned} P_D &\approx [(V_{INMAX} - V_{OUT1MIN}) \times I_{LOAD1MAX} \\ &+ [(V_{INMAX} - V_{OUT2MIN}) \times I_{LOAD2MAX} \\ &[(3.8 \times 1.05) - (1.8 \times .975)] \times 60 \times 10^{-3} \\ &+ [(3.8 \times 1.05) - (3.0 \times .975)] \times 120 \times 10^{-3} \\ &= 256mW \end{aligned}$$

Maximum allowable power dissipation:

$$\begin{aligned} P_D &= \frac{(T_{JMAX} - T_{AMAX})}{\theta_{JA}} \\ &= \frac{(125 - 55)}{200} \\ &= 350mW \end{aligned}$$

In this example, the TC1306 dissipates a maximum of 262mW; below the allowable limit of 350mW. In a similar manner, Equation 5-1 and Equation 5-2 can be used to calculate maximum current and/or input voltage limits. For example, the maximum allowable V_{IN} is found by substituting the maximum allowable power dissipation of 350mW into Equation 5-1, from which $V_{INMAX} = 4.5V$.

5.3 Layout Considerations

The primary path of heat conduction out of the package is via the package leads. Therefore, layouts having a ground plane, wide traces at the pads, and wide power supply bus lines combine to lower θ_{JA} and therefore increase the maximum allowable power dissipation limit.

6.0 TYPICAL CHARACTERISTICS

Note: The graphs and tables provided following this note are a statistical summary based on a limited number of samples and are provided for informational purposes only. The performance characteristics listed herein are not tested or guaranteed. In some graphs or tables, the data presented may be outside the specified operating range (e.g., outside specified power supply range) and therefore outside the warranted range.

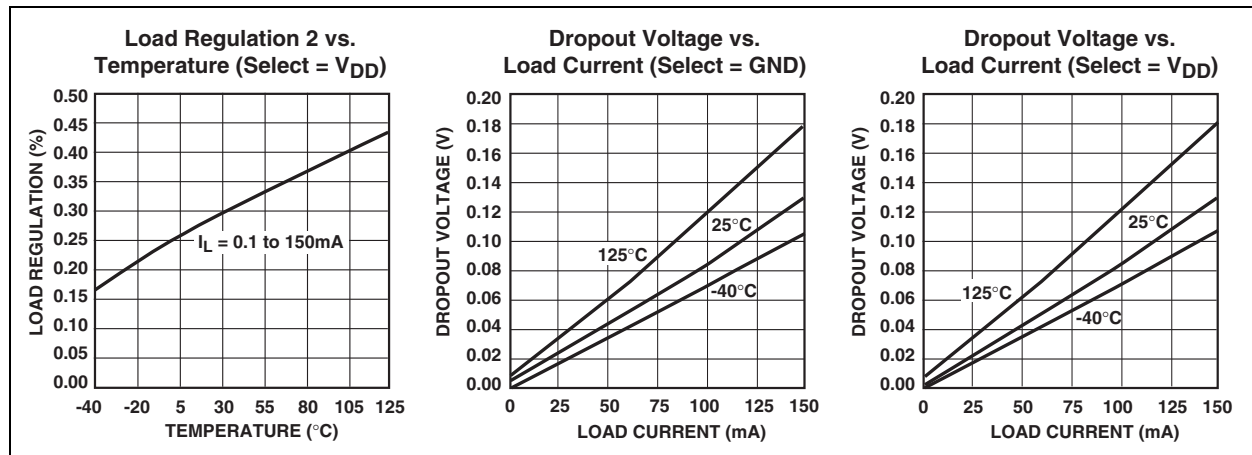
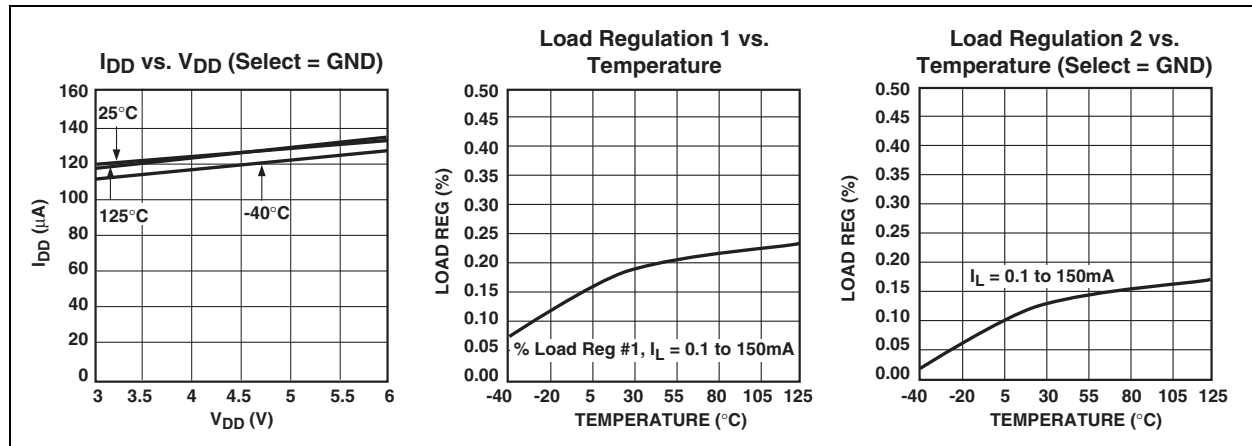
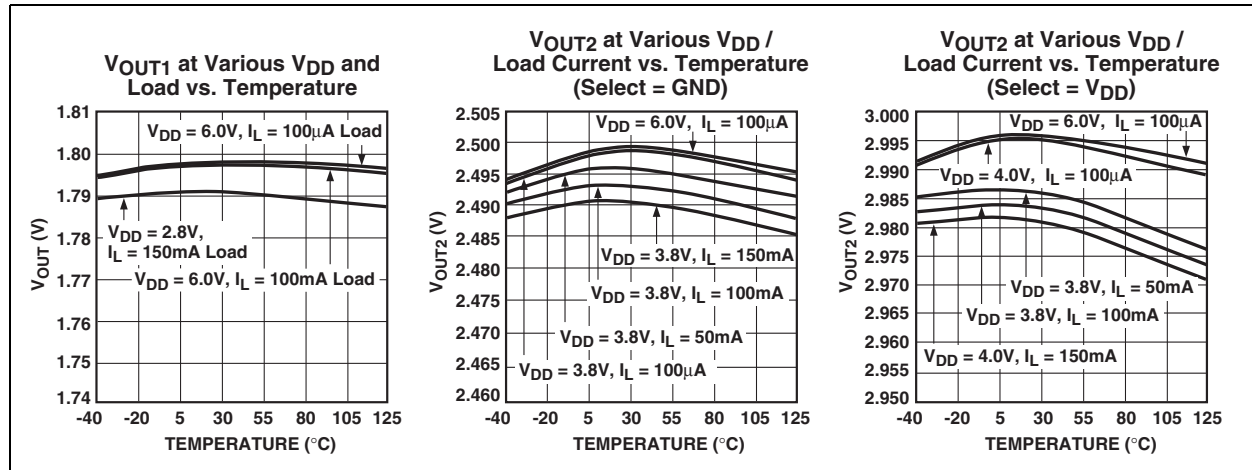

6.0 TYPICAL CHARACTERISTICS (CONTINUED)

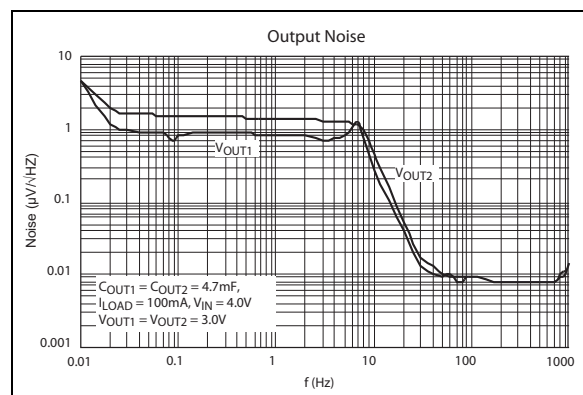
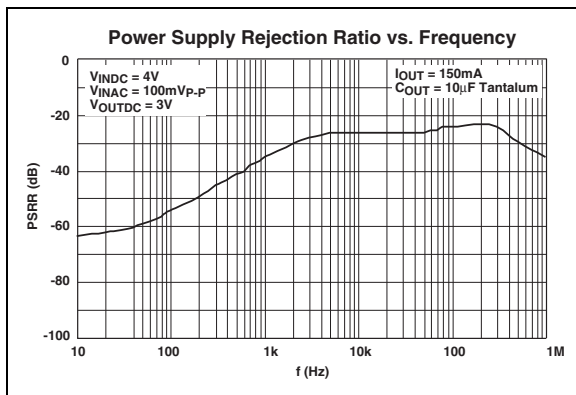
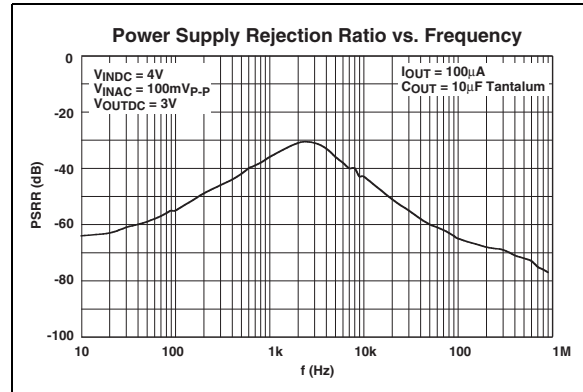
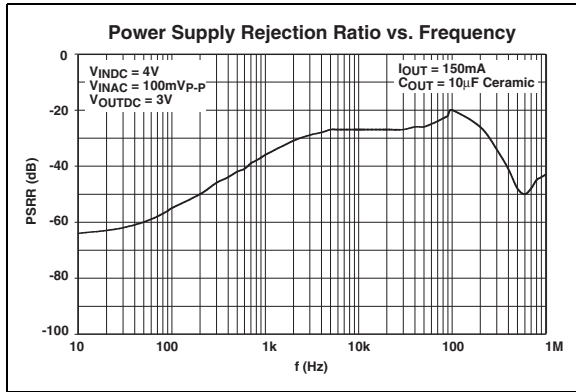

6.0 TYPICAL CHARACTERISTICS (CONTINUED)

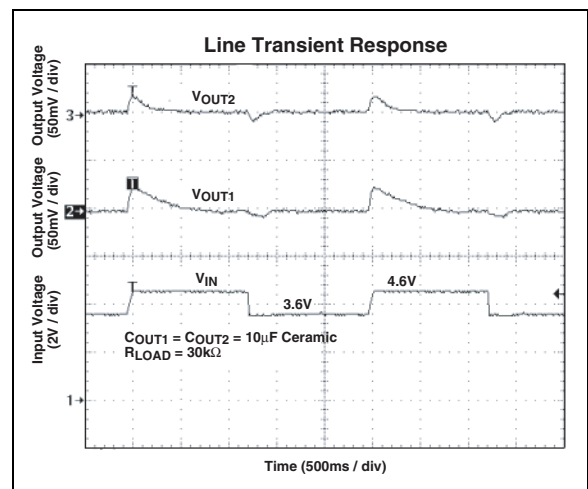
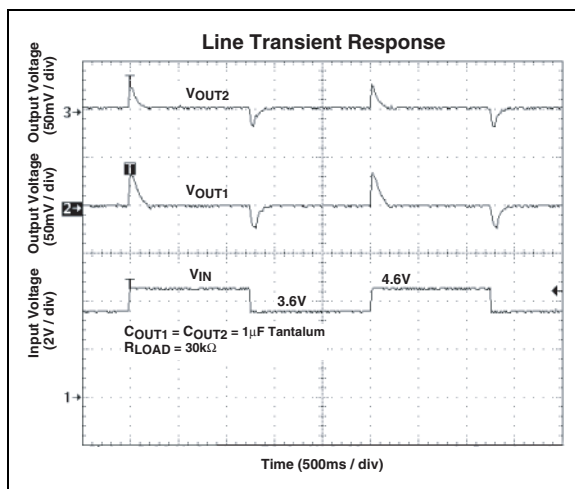
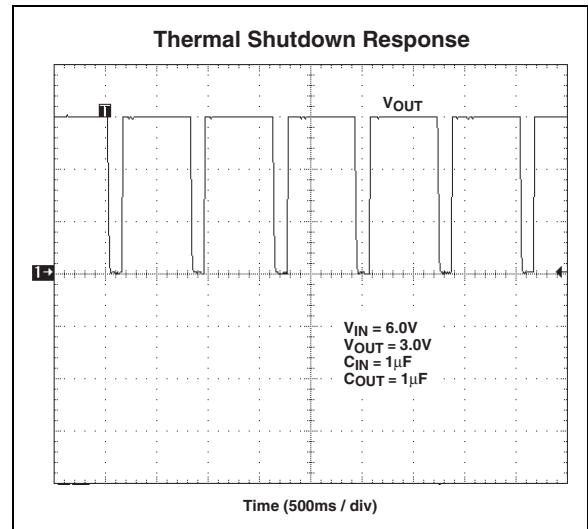
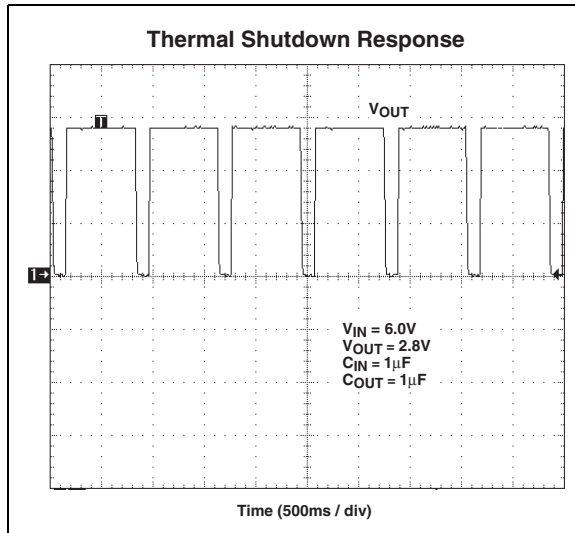
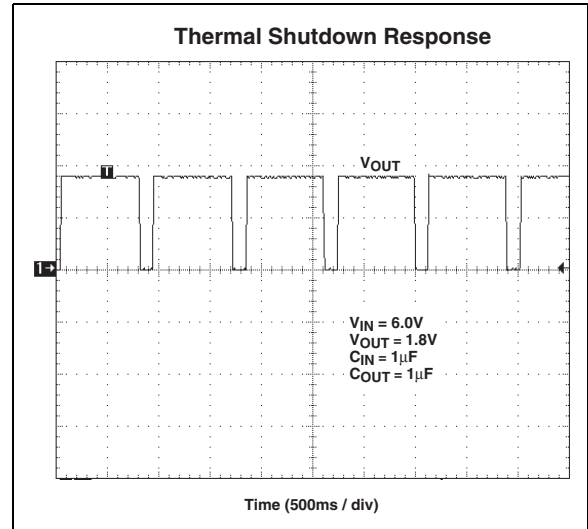
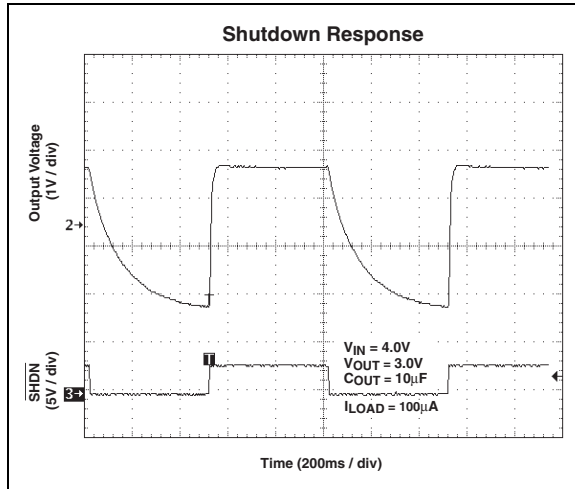

6.0 TYPICAL CHARACTERISTICS (CONTINUED)

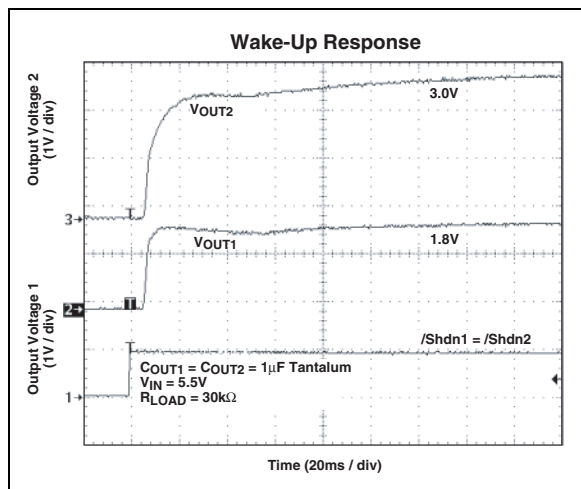
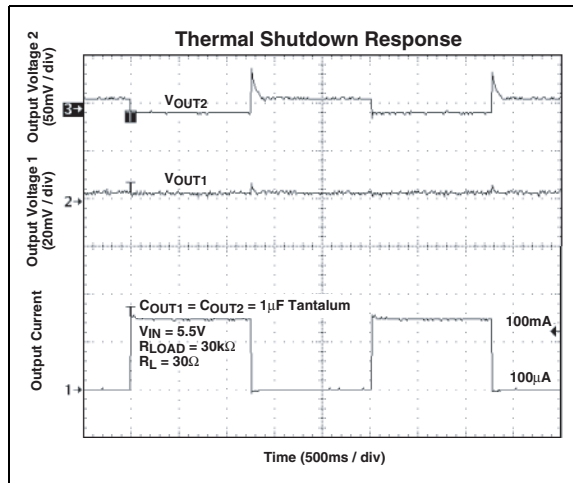
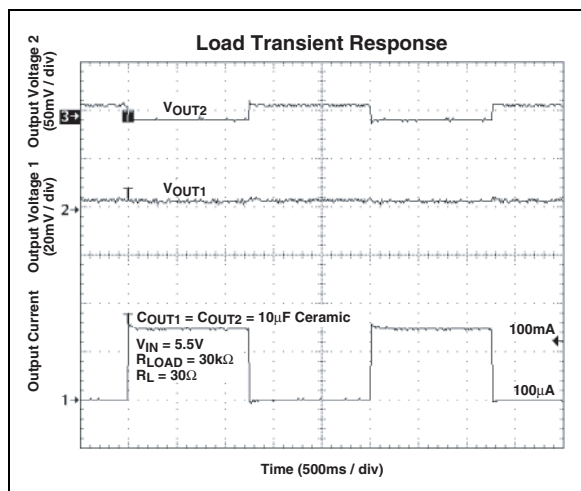
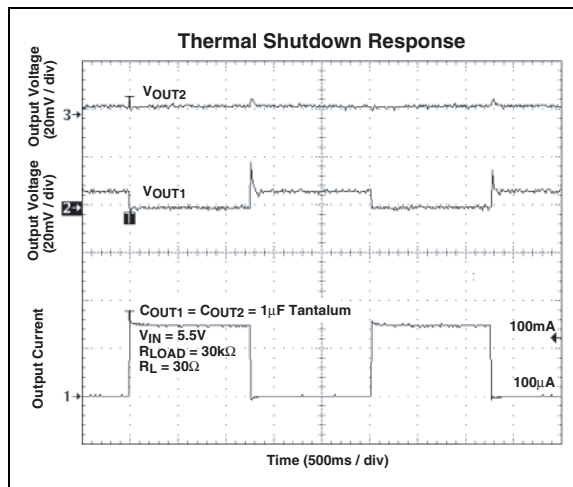
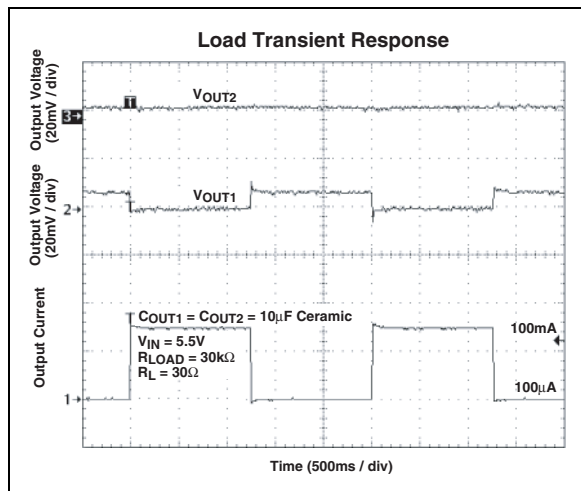

7.0 PACKAGING INFORMATION

7.1 Package Marking Information

Package marking data not available at this time.

7.2 Taping Form

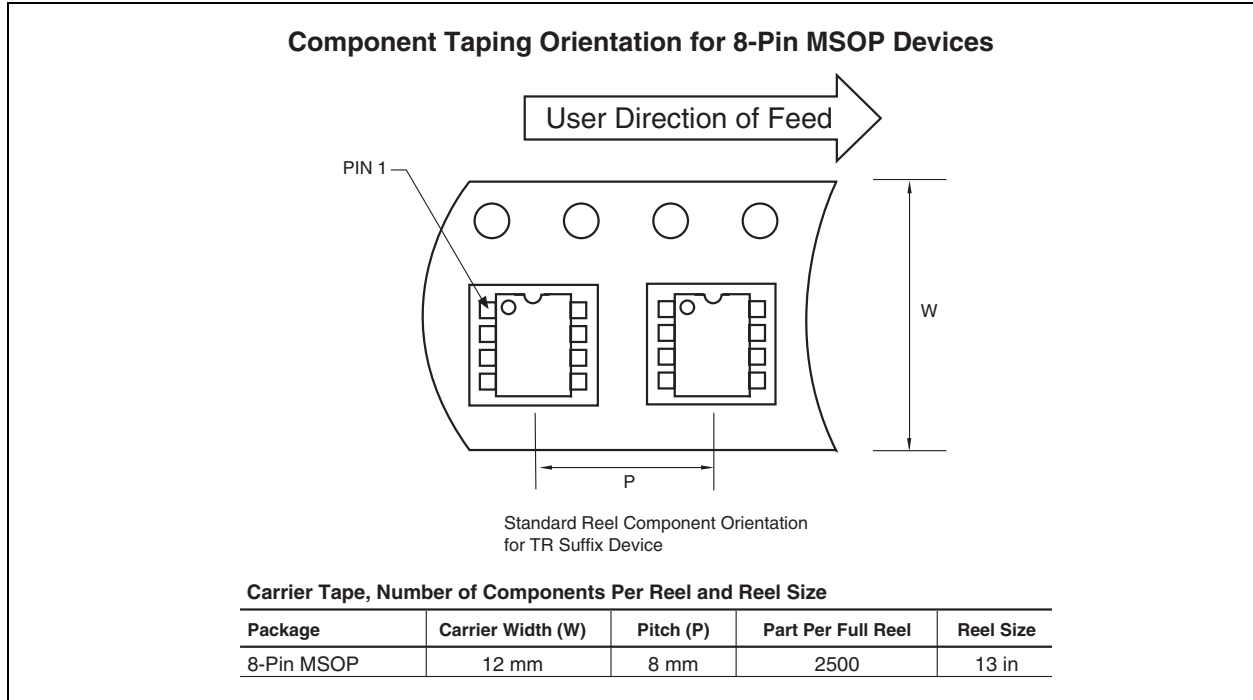

7.3 Package Dimensions

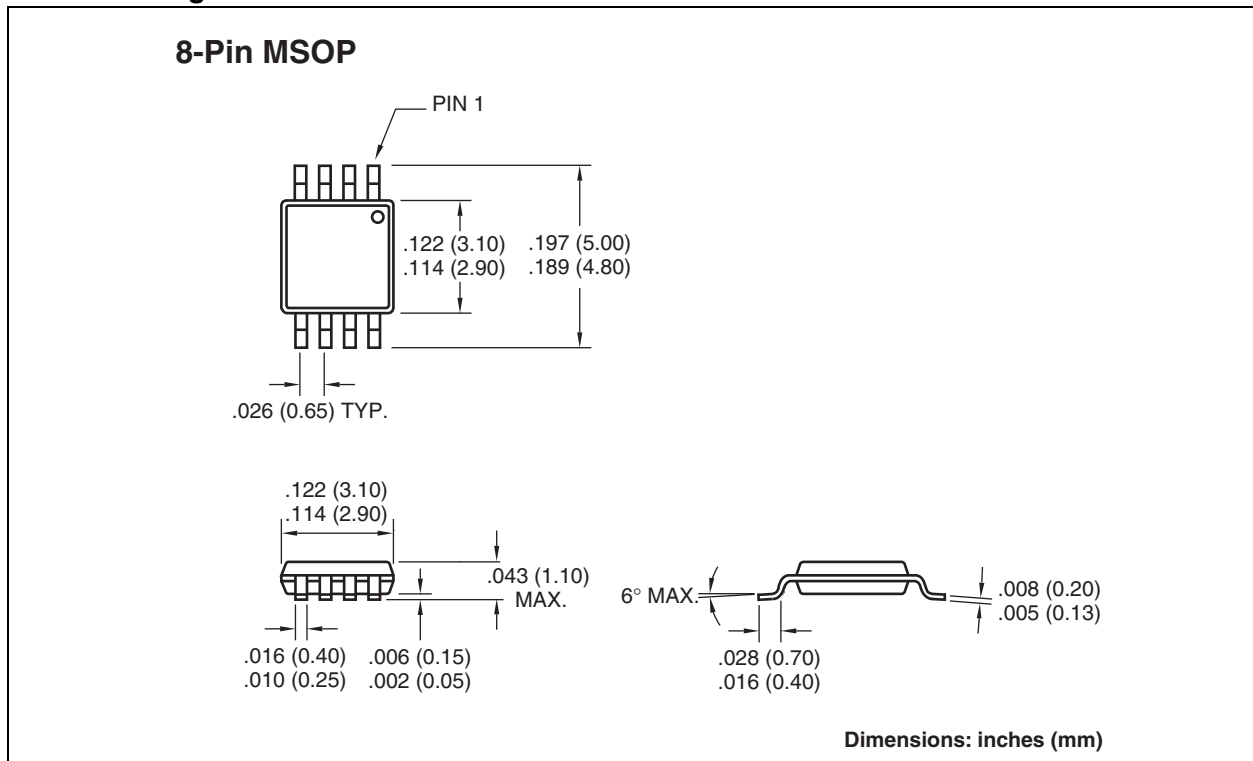

TC1306

NOTES:

APPENDIX A: REVISION HISTORY

Revision C (February 2007)

- Changed device status to “Obsolete” on data sheet
- Corrected Figure 6-4 Output Noise

Revision B (May 2002)

- Undocumented changes

Revision A (March 2001)

- Original Release of this Document.

TC1306

NOTES:

Sales and Support

Data Sheets

Products supported by a preliminary Data Sheet may have an errata sheet describing minor operational differences and recommended workarounds. To determine if an errata sheet exists for a particular device, please contact one of the following:

1. Your local Microchip sales office
2. The Microchip Corporate Literature Center U.S. FAX: (480) 792-7277
3. The Microchip Worldwide Site (www.microchip.com)

Please specify which device, revision of silicon and Data Sheet (include Literature #) you are using.

New Customer Notification System

Register on our web site (www.microchip.com/cn) to receive the most current information on our products.

TC1306

NOTES:

Note the following details of the code protection feature on Microchip devices:

- Microchip products meet the specification contained in their particular Microchip Data Sheet.
- Microchip believes that its family of products is one of the most secure families of its kind on the market today, when used in the intended manner and under normal conditions.
- There are dishonest and possibly illegal methods used to breach the code protection feature. All of these methods, to our knowledge, require using the Microchip products in a manner outside the operating specifications contained in Microchip's Data Sheets. Most likely, the person doing so is engaged in theft of intellectual property.
- Microchip is willing to work with the customer who is concerned about the integrity of their code.
- Neither Microchip nor any other semiconductor manufacturer can guarantee the security of their code. Code protection does not mean that we are guaranteeing the product as “unbreakable.”

Code protection is constantly evolving. We at Microchip are committed to continuously improving the code protection features of our products. Attempts to break Microchip's code protection feature may be a violation of the Digital Millennium Copyright Act. If such acts allow unauthorized access to your software or other copyrighted work, you may have a right to sue for relief under that Act.

Information contained in this publication regarding device applications and the like is provided only for your convenience and may be superseded by updates. It is your responsibility to ensure that your application meets with your specifications. MICROCHIP MAKES NO REPRESENTATIONS OR WARRANTIES OF ANY KIND WHETHER EXPRESS OR IMPLIED, WRITTEN OR ORAL, STATUTORY OR OTHERWISE, RELATED TO THE INFORMATION, INCLUDING BUT NOT LIMITED TO ITS CONDITION, QUALITY, PERFORMANCE, MERCHANTABILITY OR FITNESS FOR PURPOSE. Microchip disclaims all liability arising from this information and its use. Use of Microchip devices in life support and/or safety applications is entirely at the buyer's risk, and the buyer agrees to defend, indemnify and hold harmless Microchip from any and all damages, claims, suits, or expenses resulting from such use. No licenses are conveyed, implicitly or otherwise, under any Microchip intellectual property rights.

Trademarks

The Microchip name and logo, the Microchip logo, Accuron, dsPIC, KEELOQ, KEELOQ logo, microID, MPLAB, PIC, PICmicro, PICSTART, PRO MATE, PowerSmart, rPIC, and SmartShunt are registered trademarks of Microchip Technology Incorporated in the U.S.A. and other countries.

AmpLab, FilterLab, Linear Active Thermistor, Migratable Memory, MXDEV, MXLAB, PS logo, SEEVAL, SmartSensor and The Embedded Control Solutions Company are registered trademarks of Microchip Technology Incorporated in the U.S.A.

Analog-for-the-Digital Age, Application Maestro, CodeGuard, dsPICDEM, dsPICDEM.net, dsPICworks, ECAN, ECONOMONITOR, FanSense, FlexROM, fuzzyLAB, In-Circuit Serial Programming, ICSP, ICEPIC, Mindi, MiWi, MPASM, MPLAB Certified logo, MPLIB, MPLINK, PICkit, PICDEM, PICDEM.net, PICLAB, PICtail, PowerCal, PowerInfo, PowerMate, PowerTool, REAL ICE, rLAB, rfPICDEM, Select Mode, Smart Serial, SmartTel, Total Endurance, UNI/O, WiperLock and ZENA are trademarks of Microchip Technology Incorporated in the U.S.A. and other countries.

SQTP is a service mark of Microchip Technology Incorporated in the U.S.A.

All other trademarks mentioned herein are property of their respective companies.

© 2007, Microchip Technology Incorporated, Printed in the U.S.A., All Rights Reserved.

 Printed on recycled paper.

Microchip received ISO/TS-16949:2002 certification for its worldwide headquarters, design and wafer fabrication facilities in Chandler and Tempe, Arizona, Gresham, Oregon and Mountain View, California. The Company's quality system processes and procedures are for its PIC[®] MCUs and dsPIC[®] DSCs, KEELOQ[®] code hopping devices, Serial EEPROMs, microperipherals, nonvolatile memory and analog products. In addition, Microchip's quality system for the design and manufacture of development systems is ISO 9001:2000 certified.

**QUALITY MANAGEMENT SYSTEM
CERTIFIED BY DNV
== ISO/TS 16949:2002 ==**



WORLDWIDE SALES AND SERVICE

AMERICAS

Corporate Office
2355 West Chandler Blvd.
Chandler, AZ 85224-6199
Tel: 480-792-7200
Fax: 480-792-7277
Technical Support:
<http://support.microchip.com>
Web Address:
www.microchip.com

Atlanta
Duluth, GA
Tel: 678-957-9614
Fax: 678-957-1455

Boston
Westborough, MA
Tel: 774-760-0087
Fax: 774-760-0088

Chicago
Itasca, IL
Tel: 630-285-0071
Fax: 630-285-0075

Dallas
Addison, TX
Tel: 972-818-7423
Fax: 972-818-2924

Detroit
Farmington Hills, MI
Tel: 248-538-2250
Fax: 248-538-2260

Kokomo
Kokomo, IN
Tel: 765-864-8360
Fax: 765-864-8387

Los Angeles
Mission Viejo, CA
Tel: 949-462-9523
Fax: 949-462-9608

Santa Clara
Santa Clara, CA
Tel: 408-961-6444
Fax: 408-961-6445

Toronto
Mississauga, Ontario,
Canada
Tel: 905-673-0699
Fax: 905-673-6509

ASIA/PACIFIC

Asia Pacific Office
Suites 3707-14, 37th Floor
Tower 6, The Gateway
Harbour City, Kowloon
Hong Kong
Tel: 852-2401-1200
Fax: 852-2401-3431

Australia - Sydney
Tel: 61-2-9868-6733
Fax: 61-2-9868-6755

China - Beijing
Tel: 86-10-8528-2100
Fax: 86-10-8528-2104

China - Chengdu
Tel: 86-28-8665-5511
Fax: 86-28-8665-7889

China - Fuzhou
Tel: 86-591-8750-3506
Fax: 86-591-8750-3521

China - Hong Kong SAR
Tel: 852-2401-1200
Fax: 852-2401-3431

China - Qingdao
Tel: 86-532-8502-7355
Fax: 86-532-8502-7205

China - Shanghai
Tel: 86-21-5407-5533
Fax: 86-21-5407-5066

China - Shenyang
Tel: 86-24-2334-2829
Fax: 86-24-2334-2393

China - Shenzhen
Tel: 86-755-8203-2660
Fax: 86-755-8203-1760

China - Shunde
Tel: 86-757-2839-5507
Fax: 86-757-2839-5571

China - Wuhan
Tel: 86-27-5980-5300
Fax: 86-27-5980-5118

China - Xian
Tel: 86-29-8833-7250
Fax: 86-29-8833-7256

ASIA/PACIFIC

India - Bangalore
Tel: 91-80-4182-8400
Fax: 91-80-4182-8422

India - New Delhi
Tel: 91-11-4160-8631
Fax: 91-11-4160-8632

India - Pune
Tel: 91-20-2566-1512
Fax: 91-20-2566-1513

Japan - Yokohama
Tel: 81-45-471-6166
Fax: 81-45-471-6122

Korea - Gumi
Tel: 82-54-473-4301
Fax: 82-54-473-4302

Korea - Seoul
Tel: 82-2-554-7200
Fax: 82-2-558-5932 or
82-2-558-5934

Malaysia - Penang
Tel: 60-4-646-8870
Fax: 60-4-646-5086

Philippines - Manila
Tel: 63-2-634-9065
Fax: 63-2-634-9069

Singapore
Tel: 65-6334-8870
Fax: 65-6334-8850

Taiwan - Hsin Chu
Tel: 886-3-572-9526
Fax: 886-3-572-6459

Taiwan - Kaohsiung
Tel: 886-7-536-4818
Fax: 886-7-536-4803

Taiwan - Taipei
Tel: 886-2-2500-6610
Fax: 886-2-2508-0102

Thailand - Bangkok
Tel: 66-2-694-1351
Fax: 66-2-694-1350

EUROPE

Austria - Wels
Tel: 43-7242-2244-39
Fax: 43-7242-2244-393

Denmark - Copenhagen
Tel: 45-4450-2828
Fax: 45-4485-2829

France - Paris
Tel: 33-1-69-53-63-20
Fax: 33-1-69-30-90-79

Germany - Munich
Tel: 49-89-627-144-0
Fax: 49-89-627-144-44

Italy - Milan
Tel: 39-0331-742611
Fax: 39-0331-466781

Netherlands - Drunen
Tel: 31-416-690399
Fax: 31-416-690340

Spain - Madrid
Tel: 34-91-708-08-90
Fax: 34-91-708-08-91

UK - Wokingham
Tel: 44-118-921-5869
Fax: 44-118-921-5820